

Attingham

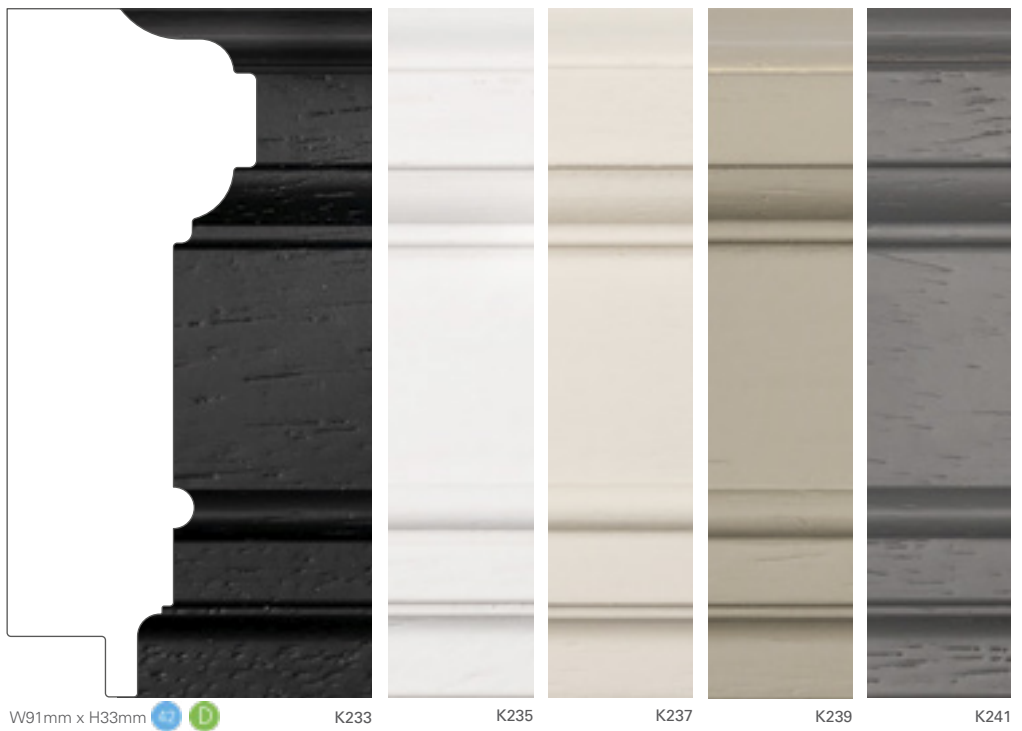
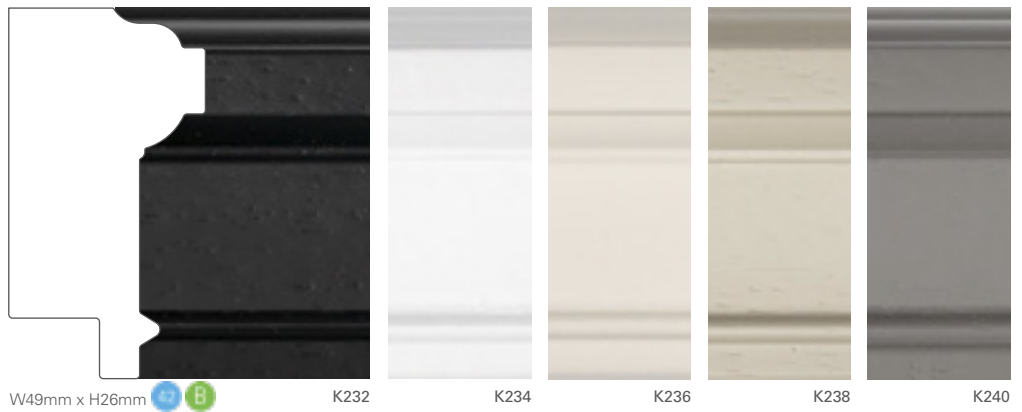

Agnes Moreschi

Mount combinations

MOUNTS	MEDIUM	LARGE
Standard	✓	✓
Double Standard	✓	✓
Triple Standard	✓	✓
Quad Standard	✓	✓
Deep	✓	✓
Duo	✓	✓
Spacer or 3D		
Duo Spacer		
Fillet		
Duowrap	✓	✓

MOUNTS	MEDIUM	LARGE
Paperwrap		
3D-Groove	✓	✓
Atoll		
Double Groove	✓	✓
Luxe	✓	✓
Double Luxe	✓	✓
Fillet Overlay		
Spacer Overlay		
Paperwrap Overlay		
Duo Overlay	✓	✓

Cadre

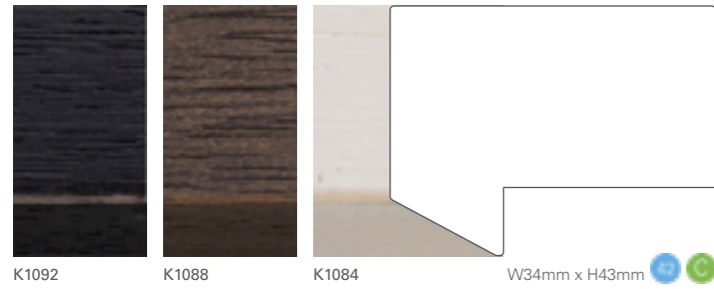

K1092 K1088 K1084 W34mm x H43mm



K1093 K1089 K1085 W48mm x H26mm

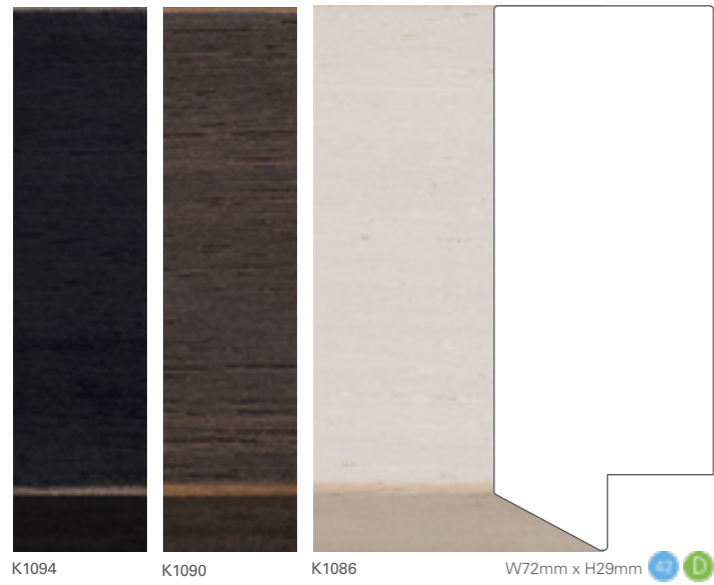

K1094 K1090 K1086 W72mm x H29mm



Andy Biggar Photography

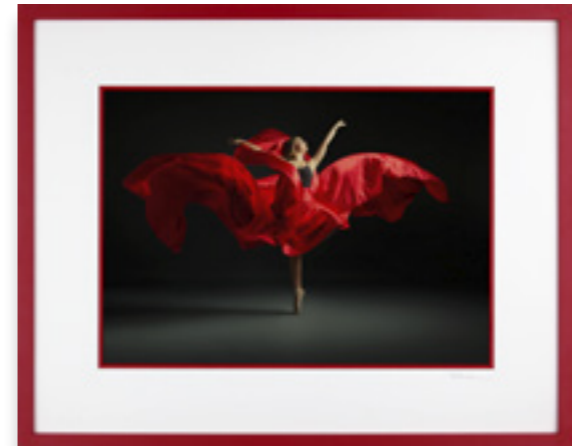

Paul Wilkinson Photography

Confetti

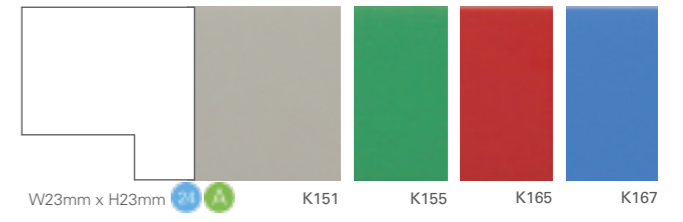

W23mm x H23mm K151 K155 K165 K167



K169 K171 K173 K175 K177

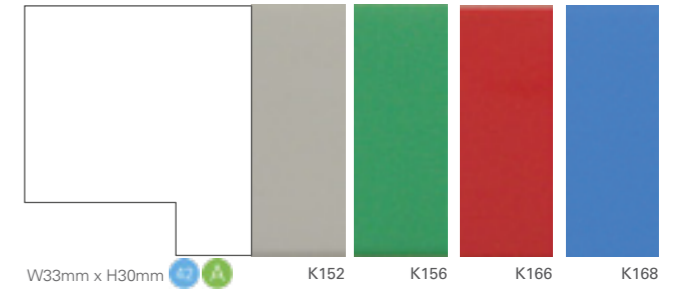

W33mm x H30mm K152 K156 K166 K168



K170 K172 K174 K176 K178



F061 F063 F068 F069 F070 F071 F072 F073 F074

Matching fillets available in all colours

Mount combinations

MOUNTS	MEDIUM	LARGE	SQUARE
Standard	✓	✓	✓
Double Standard	✓	✓	✓
Triple Standard	✓	✓	✓
Quad Standard	✓	✓	✓
Deep	✓	✓	✓
Duo	✓	✓	✓
Spacer or 3D		✓	✓
Duo Spacer		✓	✓
Fillet			
Duowrap	✓	✓	✓

MOUNTS	MEDIUM	LARGE	SQUARE
Paperwrap		✓	✓
3D-Groove	✓	✓	✓
Atoll			✓
Double Groove	✓	✓	✓
Luxe	✓	✓	✓
Double Luxe	✓	✓	✓
Fillet Overlay			
Spacer Overlay		✓	✓
Paperwrap Overlay			✓
Duo Overlay	✓	✓	✓

Mount combinations

MOUNTS	SMALL	MEDIUM
Standard	✓	✓
Double Standard	✓	✓
Triple Standard	✓	✓
Quad Standard	✓	✓
Deep	✓	✓
Duo	✓	✓
Spacer or 3D	✓	✓
Duo Spacer	✓	✓
Fillet	✓	✓
Duowrap	✓	✓

MOUNTS	SMALL	MEDIUM
Paperwrap	✓	✓
3D-Groove	✓	✓
Atoll	✓	✓
Double Groove	✓	✓
Luxe	✓	✓
Double Luxe	✓	✓
Fillet Overlay	✓	✓
Spacer Overlay	✓	✓
Paperwrap Overlay		✓
Duo Overlay	✓	✓

Delta

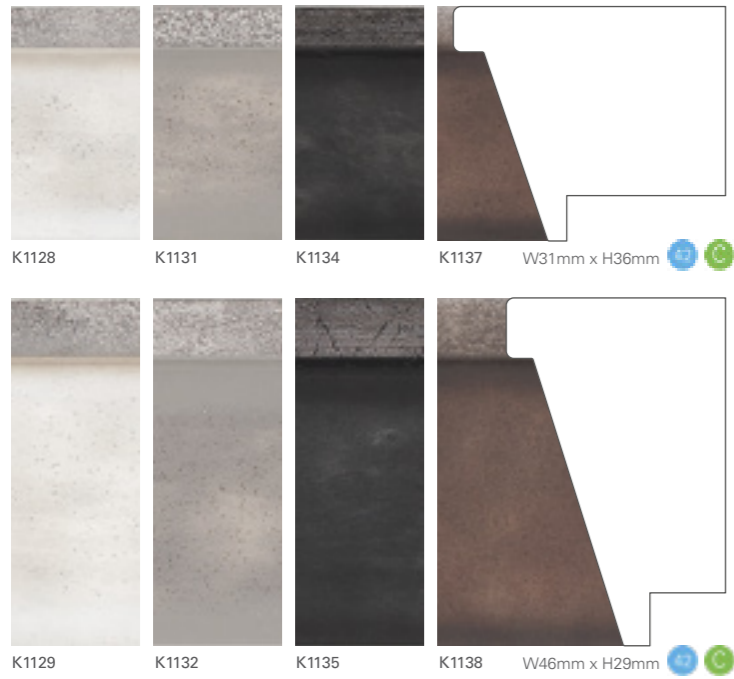

Andy Biggar Photography

Ember



Jo Robbens Photography

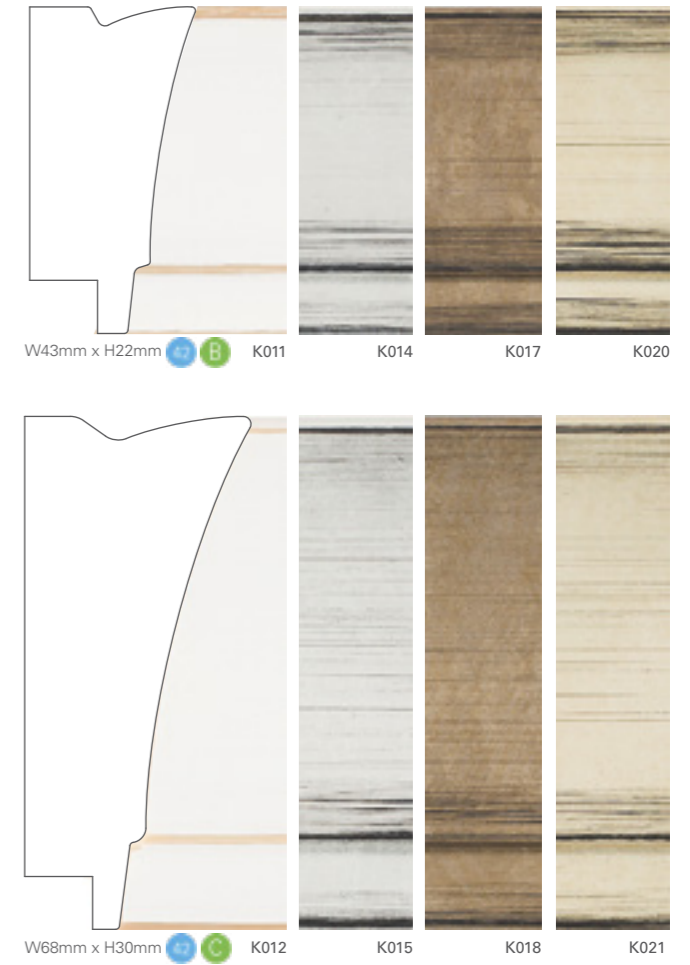

Mount combinations

MOUNTS	MEDIUM	LARGE	MOUNTS	MEDIUM	LARGE
Standard	✓	✓	Paperwrap	✓	
Double Standard	✓	✓	3D-Groove	✓	
Triple Standard	✓	✓	Atoll	✓	
Quad Standard	✓		Double Groove	✓	✓
Deep	✓	✓	Luxe	✓	✓
Duo	✓	✓	Double Luxe	✓	✓
Spacer or 3D	✓		Fillet Overlay		
Duo Spacer	✓		Spacer Overlay	✓	
Fillet			Paperwrap Overlay	✓	
Duowrap	✓	✓	Duo Overlay	✓	

Mount combinations

MOUNTS	MEDIUM	LARGE	MOUNTS	MEDIUM	LARGE
Standard	✓	✓	Paperwrap		
Double Standard	✓	✓	3D-Groove		
Triple Standard	✓	✓	Atoll		
Quad Standard			Double Groove	✓	✓
Deep	✓	✓	Luxe	✓	✓
Duo			Double Luxe		
Spacer or 3D			Fillet Overlay		
Duo Spacer			Spacer Overlay		
Fillet			Paperwrap Overlay		
Duowrap			Duo Overlay		

Essence

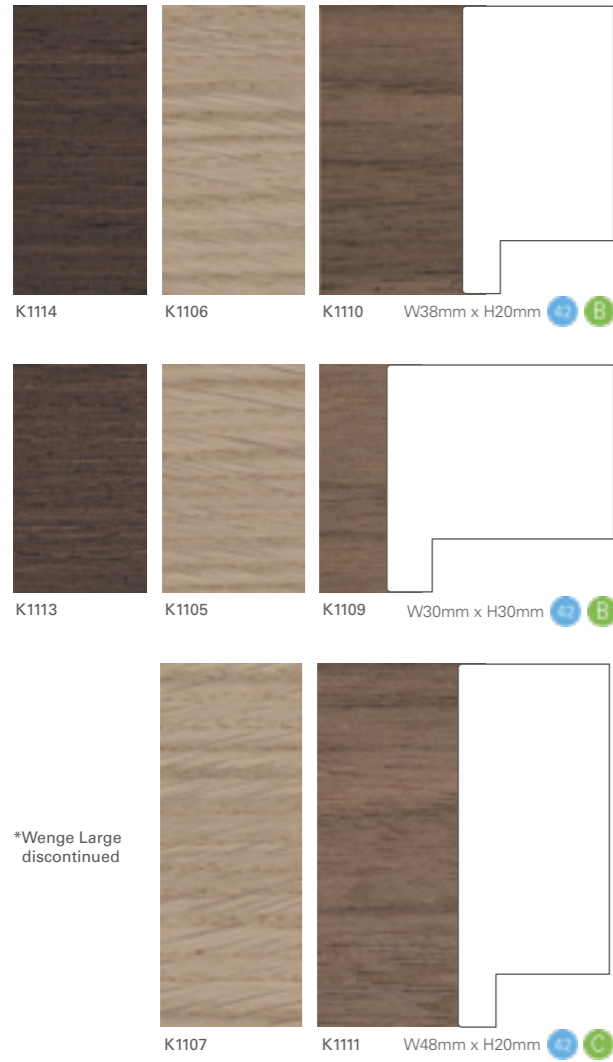

Mackney Photography



Shutter & Co Photography

Gower



Mount combinations

MOUNTS	MEDIUM	LARGE	SQUARE
Standard	✓	✓	✓
Double Standard	✓	✓	✓
Triple Standard	✓	✓	✓
Quad Standard	✓	✓	✓
Deep	✓	✓	✓
Duo	✓	✓	✓
Spacer or 3D	✓	✓	✓
Duo Spacer	✓	✓	✓
Fillet			
Duowrap	✓	✓	✓

MOUNTS	MEDIUM	LARGE	SQUARE
Paperwrap	✓	✓	✓
3D-Groove	✓	✓	✓
Atoll			✓
Double Groove	✓	✓	✓
Luxe	✓	✓	✓
Double Luxe	✓	✓	✓
Fillet Overlay			
Spacer Overlay	✓	✓	✓
Paperwrap Overlay			✓
Duo Overlay	✓	✓	✓

Information

These mouldings have a natural hardwood veneer. The appearance of natural wood is not constant. At point of order there may be variances in both colour and grain. With age, all finishes will oxidise and darken.

Mount combinations

MOUNTS	SMALL	DEEP	MEDIUM	SQUARE
Standard	✓	✓	✓	✓
Double Standard	✓	✓	✓	✓
Triple Standard		✓	✓	✓
Quad Standard		✓		✓
Deep	✓	✓	✓	✓
Duo		✓	✓	✓
Spacer or 3D		✓		✓
Duo Spacer		✓		✓
Fillet				
Duowrap		✓	✓	✓

MOUNTS	SMALL	DEEP	MEDIUM	SQUARE
Paperwrap		✓		✓
3D-Groove		✓		✓
Atoll		✓		✓
Double Groove	✓	✓	✓	✓
Luxe	✓	✓	✓	✓
Double Luxe		✓	✓	✓
Fillet Overlay				
Spacer Overlay		✓		✓
Paperwrap Overlay		✓		✓
Duo Overlay		✓		✓

Havana

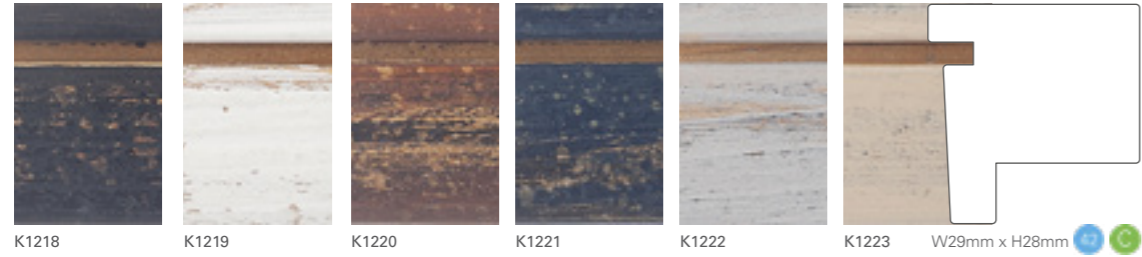

Mount combinations

MOUNTS	MEDIUM	MOUNTS	MEDIUM
Standard	✓	Paperwrap	✓
Double Standard	✓	3D-Groove	✓
Triple Standard	✓	Atoll	✓
Quad Standard	✓	Double Groove	✓
Deep	✓	Luxe	✓
Duo	✓	Double Luxe	✓
Spacer or 3D	✓	Fillet Overlay	
Duo Spacer	✓	Spacer Overlay	✓
Fillet		Paperwrap Overlay	✓
Duowrap	✓	Duo Overlay	✓



Helen Spiegl Photography

Lakeside

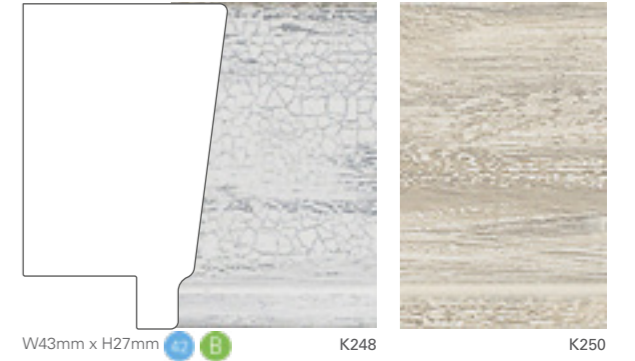

Mount combinations

MOUNTS	MEDIUM	MOUNTS	MEDIUM
Standard	✓	Paperwrap	✓
Double Standard	✓	3D-Groove	✓
Triple Standard	✓	Atoll	✓
Quad Standard	✓	Double Groove	✓
Deep	✓	Luxe	✓
Duo	✓	Double Luxe	✓
Spacer or 3D	✓	Fillet Overlay	
Duo Spacer	✓	Spacer Overlay	✓
Fillet		Paperwrap Overlay	✓
Duowrap	✓	Duo Overlay	✓



Drew Tommons Photographer

Kendal

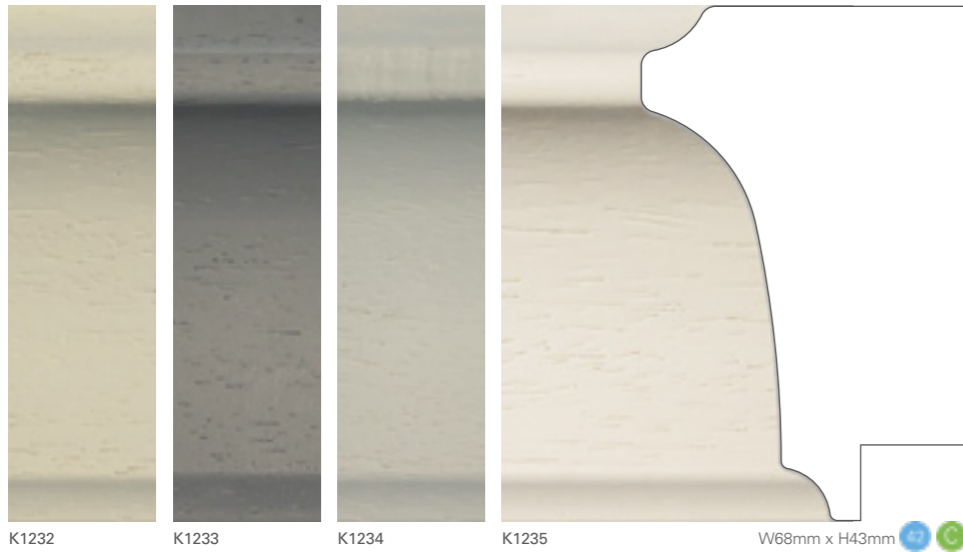

Mount combinations

MOUNTS	MEDIUM	MOUNTS	MEDIUM
Standard	✓	Paperwrap	✓
Double Standard	✓	3D-Groove	✓
Triple Standard	✓	Atoll	✓
Quad Standard	✓	Double Groove	✓
Deep	✓	Luxe	✓
Duo	✓	Double Luxe	✓
Spacer or 3D	✓	Fillet Overlay	
Duo Spacer	✓	Spacer Overlay	✓
Fillet		Paperwrap Overlay	✓
Duowrap	✓	Duo Overlay	✓

Madrid

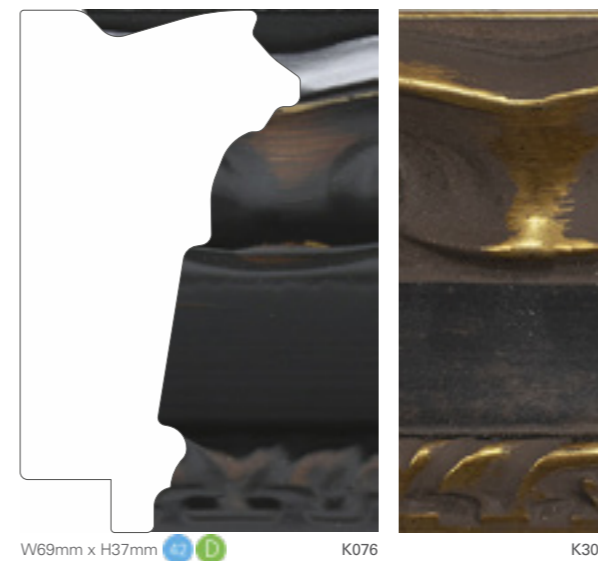

Drew Tommons Photographer

Mount combinations

MOUNTS	MEDIUM	LARGE	MOUNTS	MEDIUM	LARGE
Standard	✓	✓	Paperwrap		
Double Standard	✓	✓	3D-Groove		✓
Triple Standard		✓	Atoll		
Quad Standard		✓	Double Groove	✓	✓
Deep	✓	✓	Luxe	✓	✓
Duo		✓	Double Luxe		✓
Spacer or 3D			Fillet Overlay		
Duo Spacer			Spacer Overlay		
Fillet			Paperwrap Overlay		
Duowrap		✓	Duo Overlay		✓

Maine

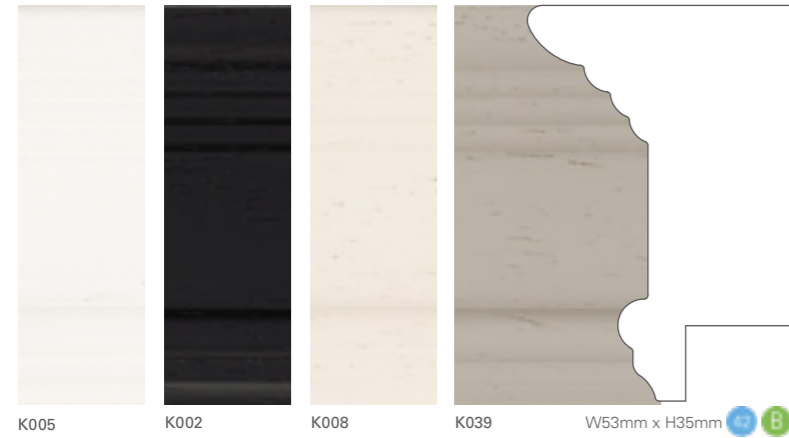

Richard Bradbury

Metallico

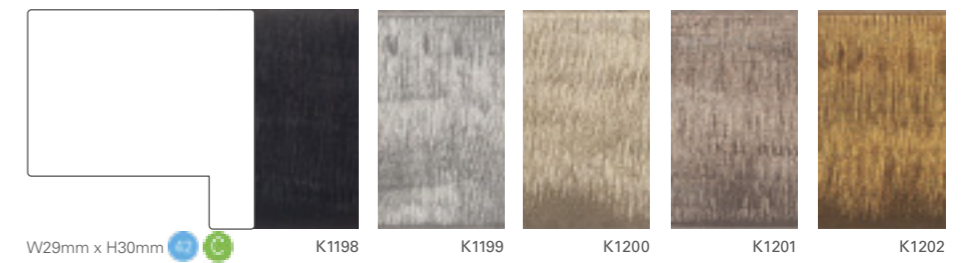
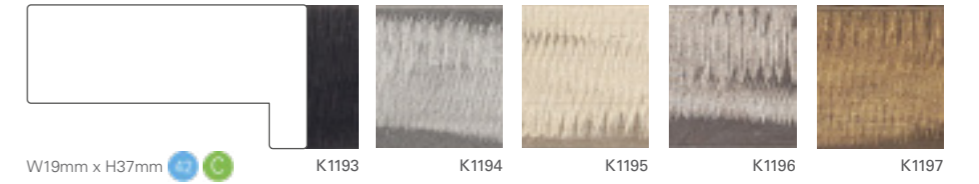
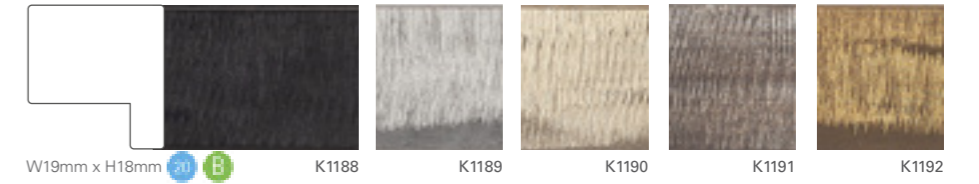

Su Kaye Photography Ltd

Mount combinations

MOUNTS	SMALL	MEDIUM	LARGE
Standard	✓	✓	✓
Double Standard	✓	✓	✓
Triple Standard	✓	✓	✓
Quad Standard	✓	✓	✓
Deep	✓	✓	✓
Duo	✓	✓	✓
Spacer or 3D		✓	✓
Duo Spacer		✓	✓
Fillet			
Duowrap	✓	✓	✓

MOUNTS	SMALL	MEDIUM	LARGE
Paperwrap		✓	✓
3D-Groove	✓	✓	✓
Atoll			✓
Double Groove	✓	✓	✓
Luxe	✓	✓	✓
Double Luxe	✓	✓	✓
Fillet Overlay			
Spacer Overlay		✓	✓
Paperwrap Overlay			✓
Duo Overlay	✓	✓	✓

Mount combinations

MOUNTS	SMALL	DEEP	SQUARE
Standard	✓	✓	✓
Double Standard	✓	✓	✓
Triple Standard	✓	✓	✓
Quad Standard	✓	✓	✓
Deep	✓	✓	✓
Duo	✓	✓	✓
Spacer or 3D	✓	✓	✓
Duo Spacer	✓	✓	✓
Fillet			
Duowrap	✓	✓	✓

MOUNTS	SMALL	DEEP	SQUARE
Paperwrap	✓	✓	✓
3D-Groove	✓	✓	✓
Atoll		✓	✓
Double Groove	✓	✓	✓
Luxe	✓	✓	✓
Double Luxe	✓	✓	✓
Fillet Overlay			
Spacer Overlay	✓	✓	✓
Paperwrap Overlay		✓	✓
Duo Overlay	✓	✓	✓

Milan

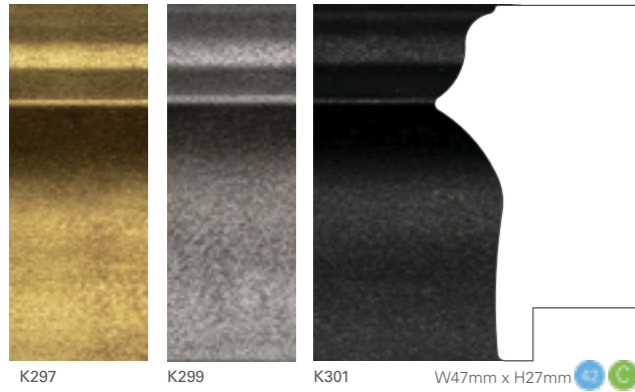

Mount combinations

MOUNTS	MEDIUM	MOUNTS	MEDIUM
Standard	✓	Paperwrap	✓
Double Standard	✓	3D-Groove	✓
Triple Standard	✓	Atoll	
Quad Standard	✓	Double Groove	✓
Deep	✓	Luxe	✓
Duo	✓	Double Luxe	✓
Spacer or 3D	✓	Fillet Overlay	
Duo Spacer	✓	Spacer Overlay	
Fillet	✓	Paperwrap Overlay	
Duowrap	✓	Duo Overlay	✓

Natur



Brett Harkness Photography

Morocco



Cary Smart Photography

Mount combinations

MOUNTS	MEDIUM	LARGE	MOUNTS	MEDIUM	LARGE
Standard	✓	✓	Paperwrap	✓	✓
Double Standard	✓	✓	3D-Groove	✓	✓
Triple Standard	✓	✓	Atoll		✓
Quad Standard	✓	✓	Double Groove	✓	✓
Deep	✓	✓	Luxe	✓	✓
Duo	✓	✓	Double Luxe	✓	✓
Spacer or 3D	✓	✓	Fillet Overlay		
Duo Spacer	✓	✓	Spacer Overlay	✓	✓
Fillet			Paperwrap Overlay		✓
Duowrap	✓	✓	Duo Overlay	✓	✓

Mount combinations

MOUNTS	MEDIUM	LARGE	MOUNTS	MEDIUM	LARGE
Standard	✓	✓	Paperwrap		
Double Standard	✓	✓	3D-Groove	✓	✓
Triple Standard	✓	✓	Atoll		
Quad Standard	✓	✓	Double Groove	✓	✓
Deep	✓	✓	Luxe	✓	✓
Duo	✓	✓	Double Luxe	✓	✓
Spacer or 3D			Fillet Overlay		
Duo Spacer			Spacer Overlay		
Fillet			Paperwrap Overlay		
Duowrap	✓	✓	Duo Overlay	✓	✓

Opus

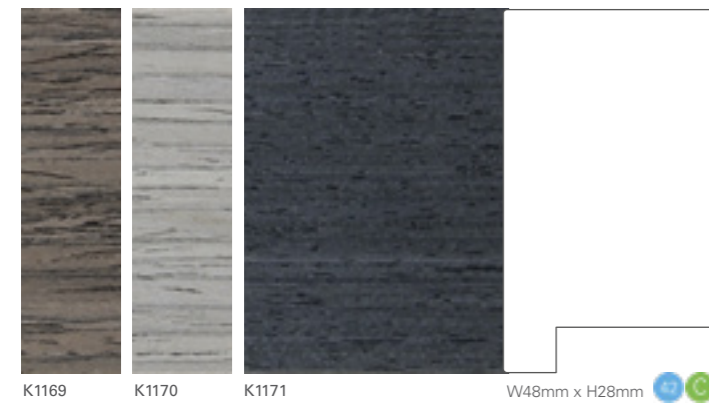
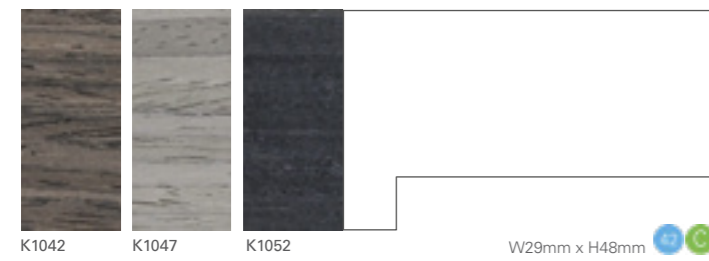
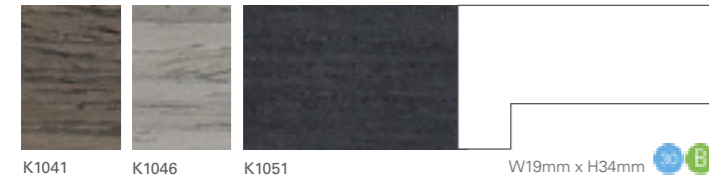
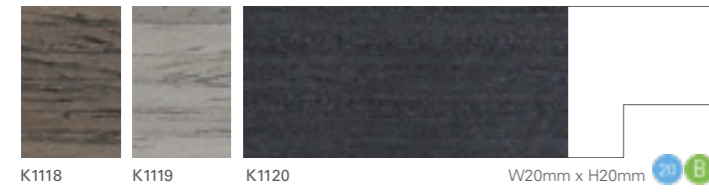

Information

These mouldings have a stained wood veneer. At point of order there may be variances in both colour and grain. With age, all finishes will oxidise and change in colour.



Ian Boichat - Origin Studios

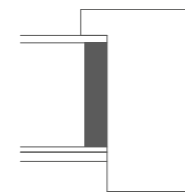

Information

The deep rebated Opus profiles can incorporate a matching wooden slip. This creates a significant distance between the contents and the glass.

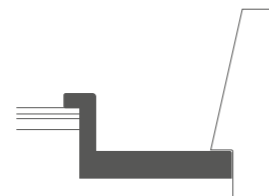

Information

The Opus bevel profile looks great as it is. For a statement piece there is a wooden shaped insert in white or off-white. This insert can hold either a laminated image or a mounted image behind glass.

Mount combinations

MOUNTS	SMALL	MEDIUM	LARGE	BEVEL	WIDE
Standard	✓	✓	✓	✓	✓
Double Standard	✓	✓	✓	✓	✓
Triple Standard	✓	✓	✓	✓	✓
Quad Standard	✓	✓	✓	✓	✓
Deep	✓	✓	✓	✓	✓
Duo	✓	✓	✓	✓	✓
Spacer or 3D		✓	✓	✓	✓
Duo Spacer		✓	✓	✓	✓
Fillet					
Duowrap	✓	✓	✓	✓	✓

MOUNTS	SMALL	MEDIUM	LARGE	BEVEL	WIDE
Paperwrap		✓	✓	✓	✓
3D-Groove	✓	✓	✓	✓	✓
Atoll		✓	✓	✓	✓
Double Groove	✓	✓	✓	✓	✓
Luxe	✓	✓	✓	✓	✓
Double Luxe	✓	✓	✓	✓	✓
Fillet Overlay					
Spacer Overlay		✓	✓	✓	✓
Paperwrap Overlay		✓	✓	✓	✓
Duo Overlay	✓	✓	✓	✓	✓

Ranger

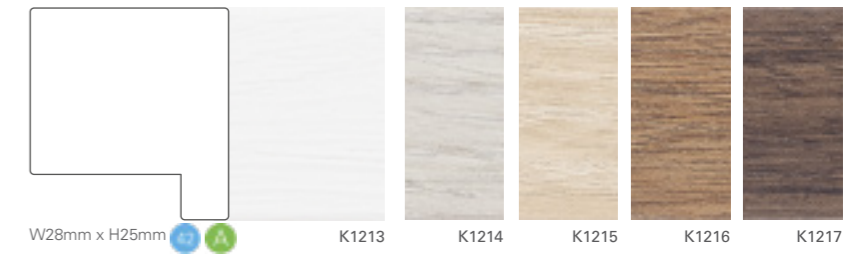
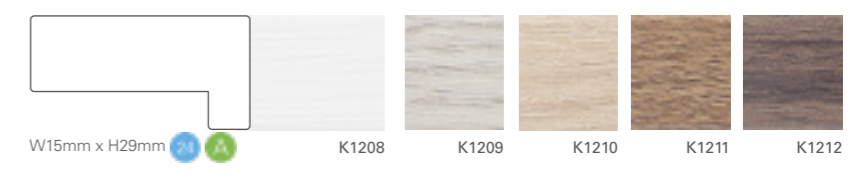
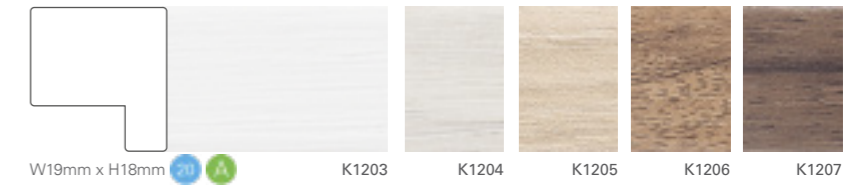

Richard Bradbury

Mount combinations

MOUNTS	SMALL	DEEP	SQUARE
Standard	✓	✓	✓
Double Standard	✓	✓	✓
Triple Standard	✓	✓	✓
Quad Standard	✓	✓	✓
Deep	✓	✓	✓
Duo	✓	✓	✓
Spacer or 3D		✓	✓
Duo Spacer		✓	✓
Fillet			
Duowrap	✓	✓	✓

MOUNTS	SMALL	DEEP	SQUARE
Paperwrap		✓	✓
3D-Groove	✓	✓	✓
Atoll		✓	✓
Double Groove	✓	✓	✓
Luxe	✓	✓	✓
Double Luxe	✓	✓	✓
Fillet Overlay			
Spacer Overlay		✓	✓
Paperwrap Overlay		✓	✓
Duo Overlay	✓	✓	✓

Shades

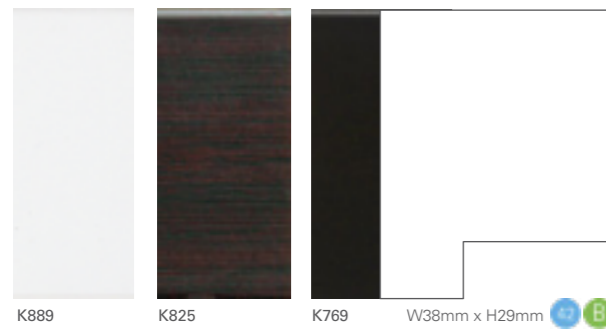
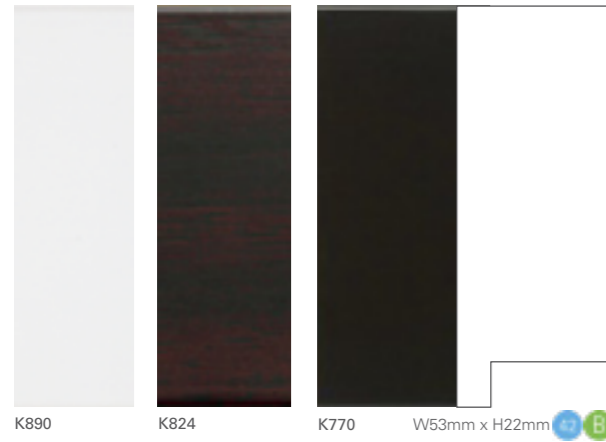
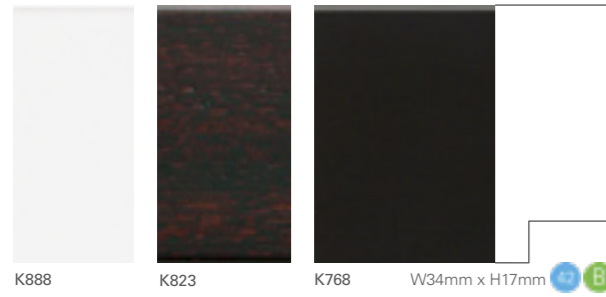

Art of the Fairytale



CatsDog Photography

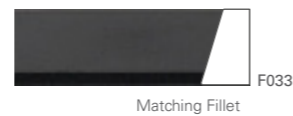

Matching Fillet

Venice

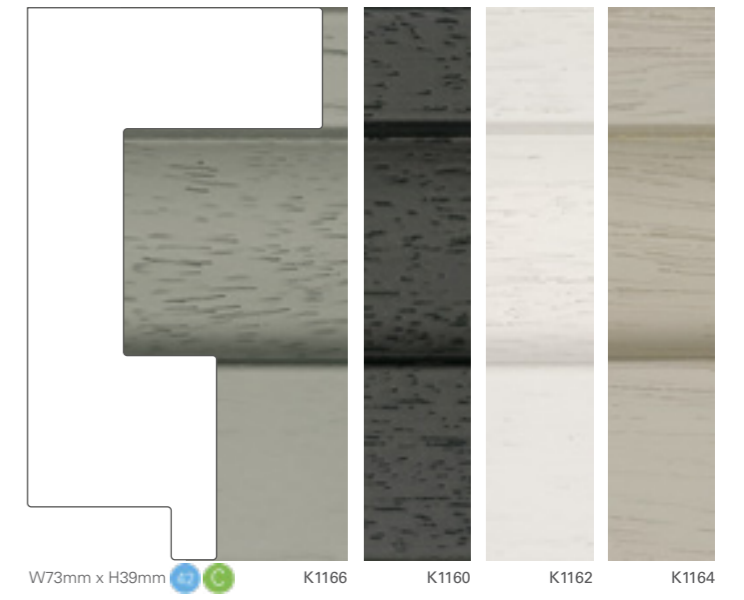
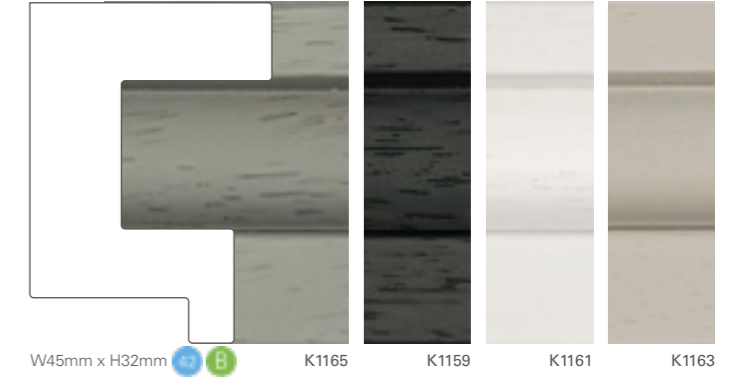

Mount combinations

MOUNTS	SMALL	MEDIUM	LARGE	SQUARE
Standard	✓	✓	✓	✓
Double Standard	✓	✓	✓	✓
Triple Standard	✓	✓	✓	✓
Quad Standard	✓	✓	✓	✓
Deep	✓	✓	✓	✓
Duo	✓	✓	✓	✓
Spacer or 3D	✓	✓	✓	✓
Duo Spacer	✓	✓	✓	✓
Fillet	✓	✓	✓	✓
Duowrap	✓	✓	✓	✓

MOUNTS	SMALL	MEDIUM	LARGE	SQUARE
Paperwrap	✓		✓	✓
3D-Groove	✓		✓	✓
Atoll	✓		✓	✓
Double Groove	✓	✓	✓	✓
Luxe	✓	✓	✓	✓
Double Luxe	✓	✓	✓	✓
Fillet Overlay	✓		✓	✓
Spacer Overlay	✓		✓	✓
Paperwrap Overlay	✓		✓	✓
Duo Overlay	✓		✓	✓

Mount combinations

MOUNTS	MEDIUM	LARGE
Standard	✓	✓
Double Standard	✓	✓
Triple Standard	✓	✓
Quad Standard	✓	✓
Deep	✓	✓
Duo	✓	✓
Spacer or 3D	✓	✓
Duo Spacer	✓	✓
Fillet	✓	✓
Duowrap	✓	✓

MOUNTS	MEDIUM	LARGE
Paperwrap	✓	✓
3D-Groove	✓	✓
Atoll	✓	✓
Double Groove	✓	✓
Luxe	✓	✓
Double Luxe	✓	✓
Fillet Overlay	✓	✓
Spacer Overlay	✓	✓
Paperwrap Overlay	✓	✓
Duo Overlay	✓	✓

Vermont



K953



K956

W26mm x H20mm



K954



K957

W46mm x H29mm



K955



K958

W76mm x H52mm



Stan Seaton Photography



Zaki Charles Photography

Zen



W44mm x H21mm

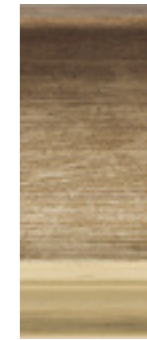

K1062



K1064

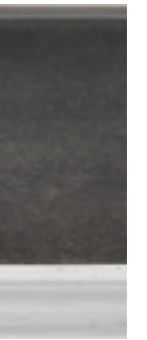

K1066



W70mm x H30mm



K1063



K1065

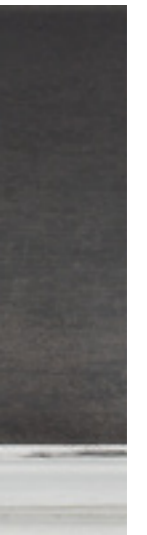

K1067

Mount combinations

MOUNTS	SMALL	MEDIUM	LARGE
Standard	✓	✓	✓
Double Standard	✓	✓	✓
Triple Standard		✓	✓
Quad Standard		✓	✓
Deep	✓	✓	✓
Duo		✓	✓
Spacer or 3D		✓	
Duo Spacer		✓	
Fillet			
Duowrap		✓	✓

MOUNTS	SMALL	MEDIUM	LARGE
Paperwrap		✓	
3D-Groove		✓	✓
Atoll			
Double Groove	✓	✓	✓
Luxe	✓	✓	✓
Double Luxe		✓	✓
Fillet Overlay			
Spacer Overlay		✓	
Paperwrap Overlay		✓	
Duo Overlay		✓	✓

Mount combinations

MOUNTS	MEDIUM	LARGE
Standard	✓	✓
Double Standard	✓	✓
Triple Standard	✓	✓
Quad Standard	✓	✓
Deep	✓	✓
Duo	✓	✓
Spacer or 3D		
Duo Spacer		
Fillet		
Duowrap	✓	✓

MOUNTS	MEDIUM	LARGE
Paperwrap		
3D-Groove	✓	✓
Atoll		
Double Groove	✓	✓
Luxe	✓	✓
Double Luxe	✓	✓
Fillet Overlay		
Spacer Overlay		
Paperwrap Overlay		
Duo Overlay	✓	✓

Mount combinations

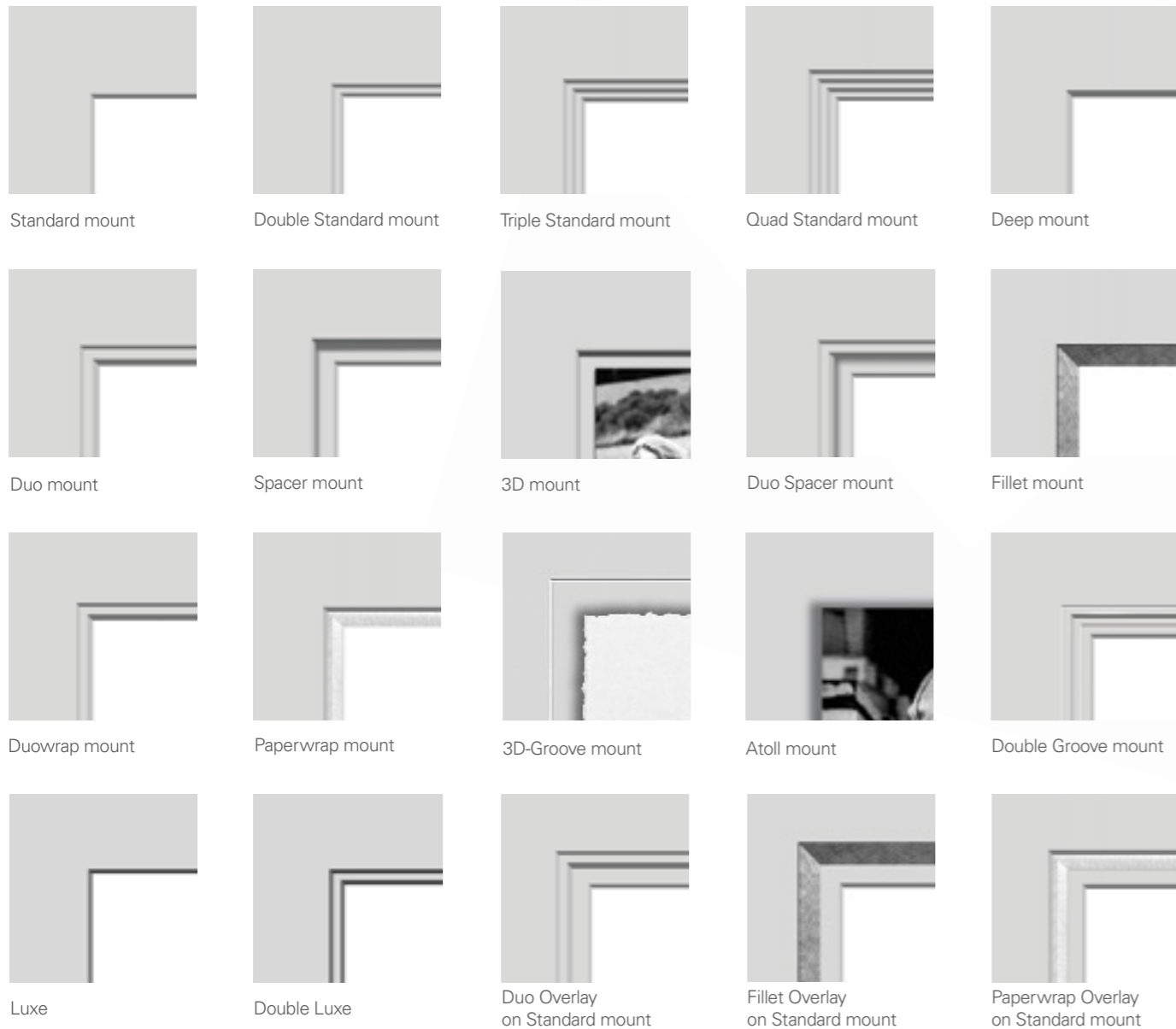

Accent layers & V grooves

Any combination can have an accent layer or V grooves. An accent layer is a contrasting colour mount layer that is positioned immediately under the topmost layer. V grooves are scored into the mount board surface for added interest.

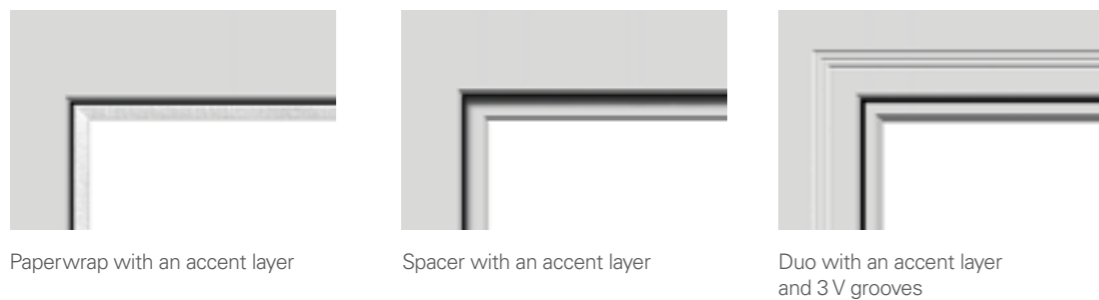

Personalisation



Replicate your signature using a pen plotter. Signature applications are available in pencil, black and silver pen, or have your signature debossed!

Replicate a signature with a self-inking stamp. Stamps can be purchased from a third party provider and will require testing before forwarding to us.

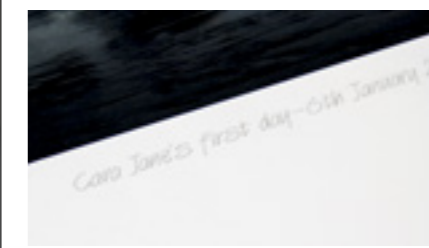

Text to complement an image(s) can be added using a pen plotter. There are a number of set fonts to choose from.

[Take a look at our website for details](#)

Mount colours



Mount Layouts

All sizes shown in inches

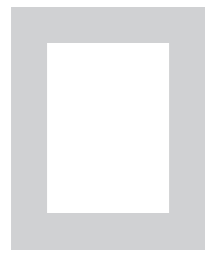

PRINT SIZE	FRAME SIZE	REF
6X4	9X7	D024
7X5	10X8	D021
8X6	10X8	D001
8X6	12X10	D016
10X7	14X11	D017
10X8	12X10	D002
10X8	14X12	E106
10X8	15X13	D005
12X8	16X12	D018
16X12	20X16	D009
18X12	24X18	D026
18X14	24X20	E110
20X16	24X20	D011
20X24	30X24	D014
20X30	30X40	D028



PRINT SIZE	FRAME SIZE	REF
6X4	9X23	D340
8X6	30X11	D300
9X6	32X12	D360
10X8	34X13	D350



PRINT SIZE	FRAME SIZE	REF
6X4	9X23	D343
8X6	30X11	D303
9X6	32X12	D363
10X8	34X13	D353



PRINT SIZE	FRAME SIZE	REF
15X10 (6X4)	33X15	D644
16X12 (7X5)	40X18	D643



PRINT SIZE	FRAME SIZE	REF
6X4	9X23	D341
8X6	30X11	D301
9X6	32X12	D361
10X8	34X13	D351



PRINT SIZE	FRAME SIZE	REF
6X4	9X23	D342
8X6	30X11	D302
9X6	32X12	D362
10X8	34X13	D352



PRINT SIZE	FRAME SIZE	REF
15X10 (6X4)	33X15	D641
16X12 (7X5)	40X18	D642



PRINT SIZE	FRAME SIZE	REF
15X12 (5X4)	24X20	D508
18X14 (7X5)	30X24	D709

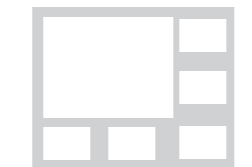

PRINT SIZE	FRAME SIZE	REF
15X12 (5X4)	24X20	D501
18X14 (7X5)	30X24	D706



PRINT SIZE	FRAME SIZE	REF
15X12 (5X4)	24X20	D504



PRINT SIZE	FRAME SIZE	REF
6X4	16X16	D486
7X5	20X20	D483
10X7	24X24	D487



PRINT SIZE	FRAME SIZE	REF
15X12 (5X4)	24X20	D502



PRINT SIZE	FRAME SIZE	REF
15X12 (5X4)	24X20	D503

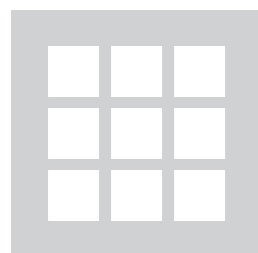

PRINT SIZE	FRAME SIZE	REF
5X5	24X24	D803
6X6	28X28	E092

A small selection of the hundreds of options available.....

Can't find what you're looking for?
Make a **Bespoke** layout!

We have developed software that enables design of your own mount layouts online. Store them for repeated use or simply modify them as required.

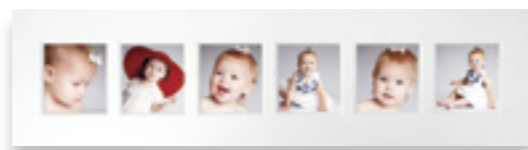

Nicholas Frost Photography



Wild Earth Fine Art

Printing

Printing is available to complement our full assembly framing service and is an integral part of the manufacturing process for the other products that we offer. We do not colour correct or edit images, we simply print the file as we receive it.

- Large format colour inkjet printer - Epson CP1000
- Canvas • Fine Art
- Ultra White • Pearlescent
- Large upload capacity via the website
- Adobe 98 & SRGB colour space accepted
- Jpeg & Tiff files accepted
- Test printing packs available

Giclée Printing

The word Giclée is derived from the French verb gicler meaning "to squirt or spray". Giclée is used to describe a fine art digital printing process combining pigment based inks with high quality paper. Giclée prints are printed on a variety of substrates or mediums, the most common being cotton rag. This fibrous paper transforms a photograph into a painterly, soft image that adds a classy, decorative feel making it perfect for everything from portfolios to art prints for exhibitions.

Surprisingly, amongst our peer group we were the first to routinely offer fine art printing. We now regularly deliver high quality print runs for artists, illustrators and photographers alike.

Available with décollage edge

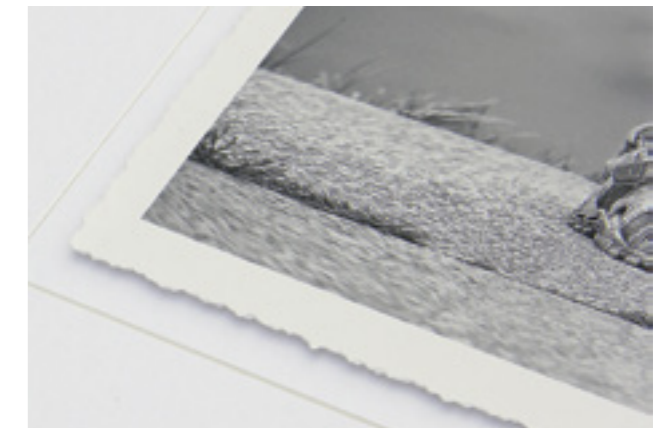

Mounted prints

You don't always need a frame. A mounted print can look exceptional if it is presented well. Mounts cut to any size, images printed to any size and supplied with a choice of backing for a neat finish. Computerised signatures can be applied along with an option to deboss.

Part of a society/association? We can help with your qualification panels, speak to us about costs and ideas as we offer reduced rates on sets of mounts.



Mackney Photography

Box Installation

Images are laminated and framed in a range of mouldings standing 31mm deep.

The layouts available have been designed to sit together within a single presentation box. Instantly the recipient gets the wow factor when the box is opened. The consumer then has the option of hanging them in the format of our design or however they choose.

See layout options opposite

- 31mm frame depth
- Satin lamination
- Pearlescent prints available

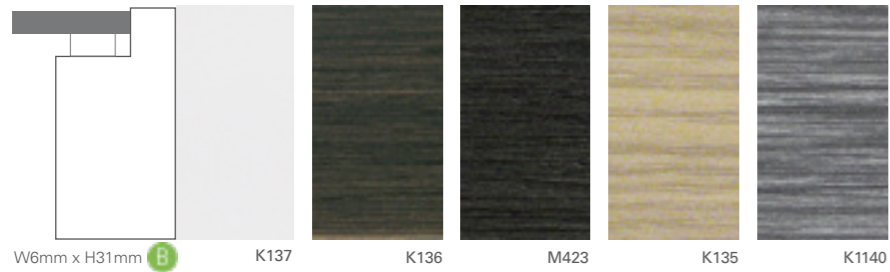

W6mm x H31mm B K137 K136 M423 K135 K1140



Brett Harkness Photography

Tek Installation

Images are framed in your choice of colour TEK frames behind glass or with a mount inside. Choose from a Standard or Deep mount combination and then select from some standard templates.

See layout options opposite

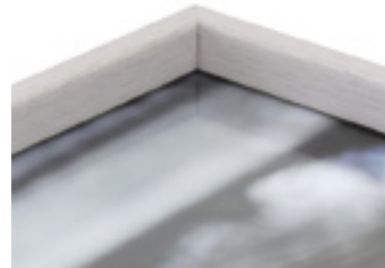

K191 Frosted Silver K192 Frosted Mercury K193 Matt Black W6mm x H35mm B



K194 Oak* K195 Limed Oak* K196 Pale Wenge* K197 Grey Oak* K198 Black Oak* W6mm x H35mm C

Information

The mouldings marked with an asterisk have a natural hardwood veneer. The appearance of natural wood is not constant. At point of order there may be variances in both colour and grain. With age, all finishes will oxidise and darken.

Installation layouts

All sizes shown in inches



IF01

IF14

IF02



IF04

IF05

IF15

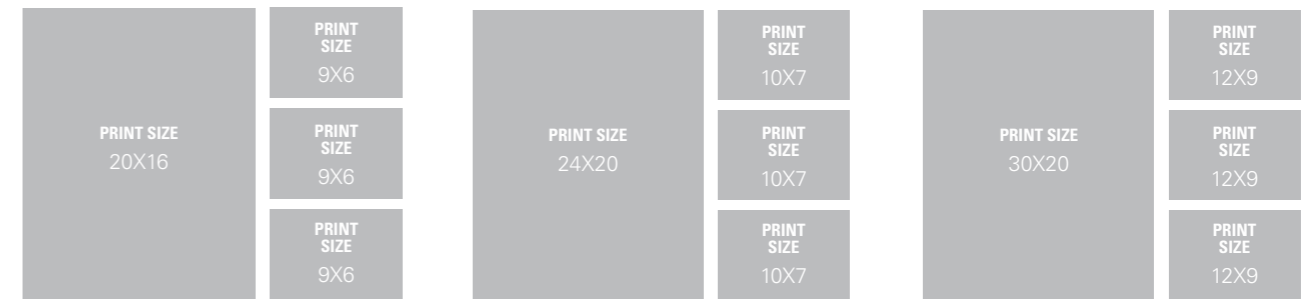

IF08

IF16

IF13

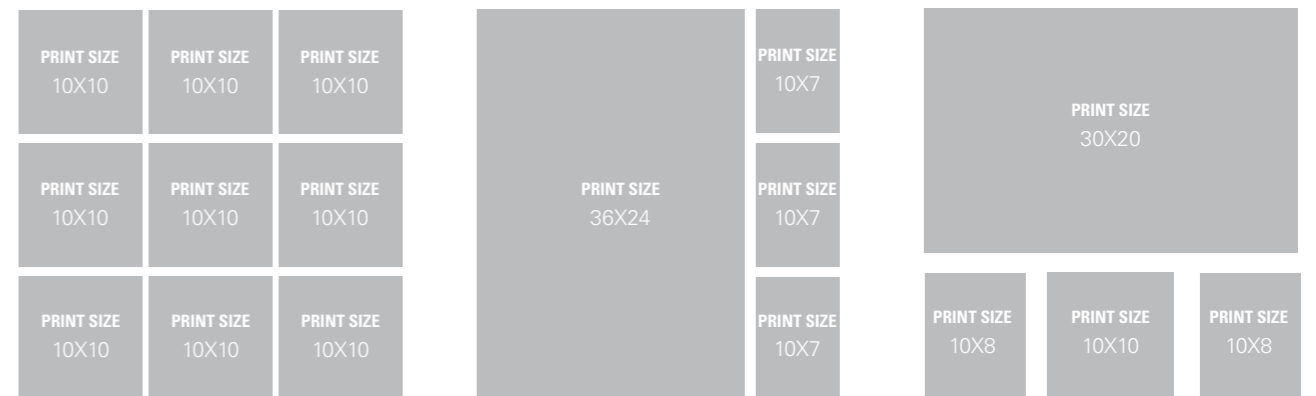

IF06

IF09

IF11



IF17

Box Frame

Prints are laminated onto 3mm PVC foam board at any size up to 48X36. The laminated print is then placed into a linear moulding. There is a range of composite mouldings that are ideal as a cost-effective yet attractive solution.

- 54mm or 31mm frame depth
- Satin lamination
- Pearlescent prints available
- Sizes up to 48 x 36 inches



Paul Wilkinson Photography

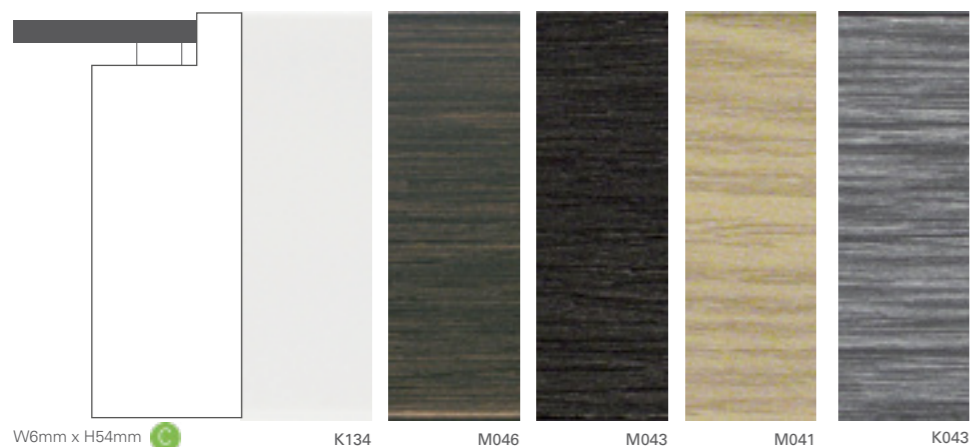

W6mm x H54mm K134 M046 M043 M041 K043

Canvas Wraps

A canvas wrap offers a display option with warmth. Utilising a poly cotton blend material softens the image whilst bringing it to life. Available as a full image wrap or with coloured edges, the depth of the canvas is also optional.

Available at any size up to 48X36 inches, they all have several coats of matt lacquer applied prior to stretching. The canvas is stretched, by hand, over a solid wood frame faced with board to prevent the canvas deforming during handling. Flush fixings allow the canvas to hug the wall.



30mm (shallow) or 55mm (deep)

Blocks



Vicki Knights Photography

The blocks are made of MDF and can be ordered at any size from 8X8 up to 48X36. Prints are laminated directly onto the blocks which can then be finished in a choice of appearances to suit budget and taste.

Block Colours



Black White Black / Silver White / Silver Oak Wenge Walnut

Desktop Blocks

Made as our other Block products but with the addition of a stand, easy to use and looks great!



Images courtesy of Shutter & Co, Paredes Photography & Paul Wilkinson Photography



- 18mm deep
- Satin lamination
- 7 edges available
- Pearlescent prints available

Block Installation

See layout options below. All sizes shown in inches

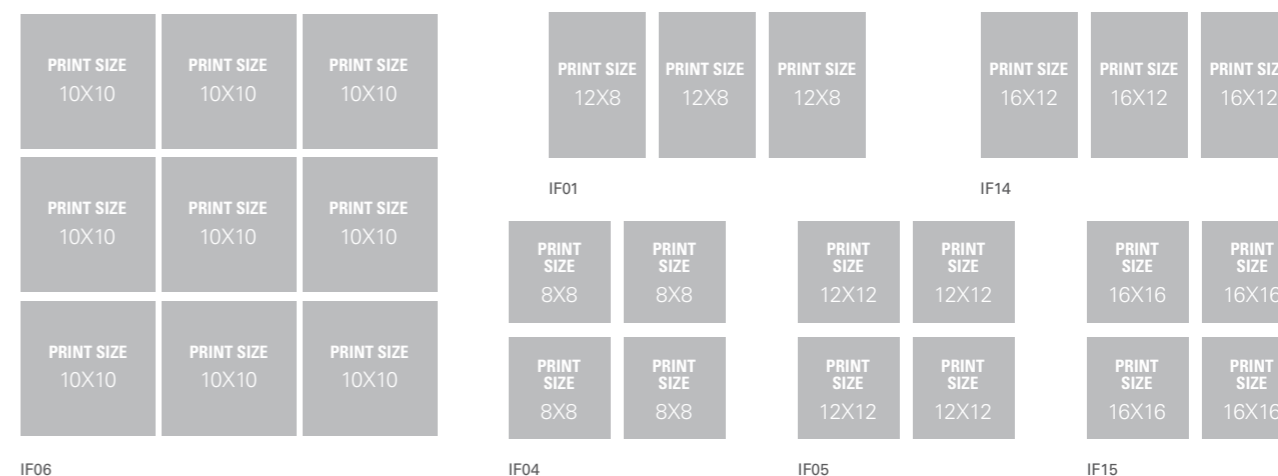

Edge

Minimalist products are in vogue. For some, whilst the sharp look is important, it can appear a little stark. This is when an Edge solution is useful. Edge is available in a number of finishes, painted woods, foils and real wood veneer wraps. Available with either Canvas Wrap or Block inner sat down within the frame, drawing the viewers eye to the image within.



W9mm x H45mm

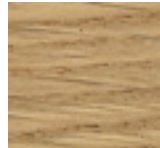

D K1178

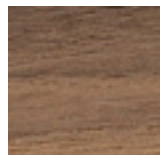

D K1179



Richard Bradbury

Canvas wrap in Edge

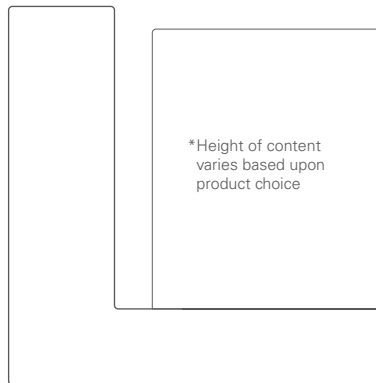

W15mm x H50mm (Approx - varies by finish)

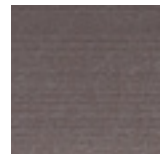

B K1175

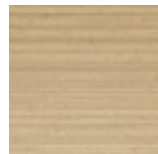

B K1176



B K1177

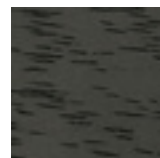

C K092

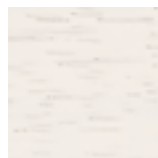

C K093



Rachel Thornhill Photography

Block in Edge



W10mm x H35mm

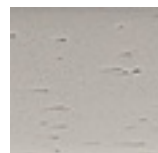

B K1224

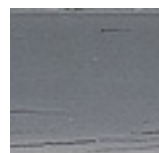

B K1225



B K1226

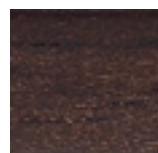

B K1227

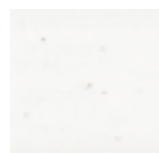

B K1228

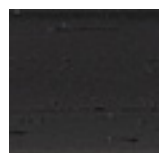

B K1229



B K1230



B K1231